

# *Platinum Series*

---

*Whirlpool Spa  
Owner's Manual*

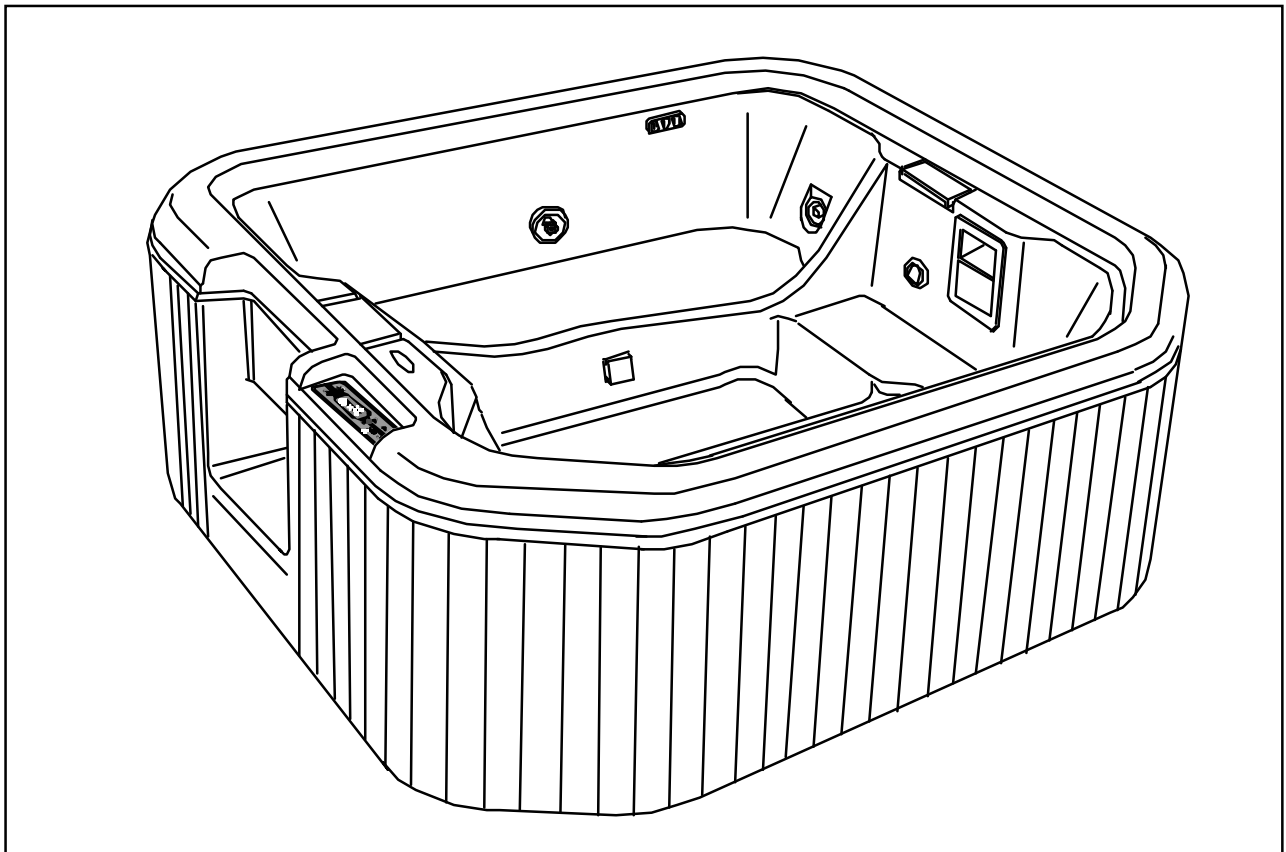

# IMPORTANT SAFETY INFORMATION

## READ AND FOLLOW ALL INSTRUCTIONS

**Warning — Risk of injury:** Children, the elderly, and the infirm should not use the spa unless they are supervised at all times. Infants should not be permitted in the spa at water temperatures over 100° F (38°C).

Spa water temperatures in excess of 104° F is not recommended. High water temperatures in excess of 104° F (40° C) and prolonged periods of use can raise internal human body temperature excessively and impair the body's ability to regulate its internal temperature.

Pregnant women and people with heart circulatory conditions, or diabetes, should consult their physicians before using the spa at water temperatures over 100° F (38° C).

Limit your initial use of the spa to 10 - 15 minutes. High body temperatures affect people differently; consult your physician about your safety and comfort before using the spa. If your spa product does not have a thermometer, we recommend that you use a medical (clinical) type thermometer for an accurate measurement of spa water temperatures. Other types of thermometers, generally available, such as those used for swimming pools are not sufficiently accurate to determine spa water temperatures.

Extra care should be taken when using the spa and consuming alcoholic beverages. Alcohol, drugs, or certain medications, such as tranquilizers, affect a person's ability to withstand high temperatures and may produce dangerous effects, including drowning. Persons using medication should consult with a physician before using a spa.

**Danger — Risk of injury:** Do not remove the suction grille! It is a safety device and must always be in place on the suction fitting to minimize the potential hazard of hair entanglement or body entrapment.

Keep body, hair, and clothing a minimum of 12 inches away from suction fitting and skimmers at all times when the spa is operating. Hair longer than shoulder length should be secured close to the head, or a bathing cap should be worn.

Do not operate the spa if the suction cover is broken or missing. Contact your Dealer for replacement cover if broken or missing.

The wet surface of the spa is slippery. Use care when entering and exiting.

**DANGER — Risk of child drowning:** Do not permit children to use this product unless they are closely supervised. The use of a locked cover is highly recommended to prevent unattended access.

**DANGER — RISK OF ELECTRICAL SHOCK:** When installing and operating this electrical equipment, basic safety precautions should always be adhered to including the following.

**Warning:** A wire connector is provided at the electrical cabinet on this spa to connect a minimum No. 8 AWG (8.4 MM<sup>2</sup>) solid copper conductor between this spa and any metal equipment, metal enclosures of electrical equipment, metal water pipe, or conduit within 5 feet (1.5 m) of the spa.

Do not use electrically connected devices such as television, radio, or stereo speakers, lights, cooking devices, or telephones within 5 feet (1.5 m) of the spa while the spa is being used. Lighting fixtures must not be located directly above or within 5 feet (1.5 m) of the spa. If located within 10 feet (3.0 m) of the spa, they must be on a circuit protected by a GFCI (Ground Fault Interrupter Circuit).

All fixed metal objects located within 5 feet of the spa, such as fence posts, railings, door frames, greenhouse structures, gutters, etc., must be attached to the bonding bar on the outside of the spa electrical cabinet using #8 solid copper wire. **With #8 solid copper wire, bond the spa to the house electrical panel or approved local bond.**

The spa must be installed with adequate access and water drainage system, refer to Installation Instructions, to drain water away from electrical components.

**CAUTION:** Do not turn power ON to the spa unless it is filled with water to the normal water level, which is to the water level indicator mark on the skimmer frame. Activating the spa when there is an insufficient amount of water can damage the circulation pump and may cause a fire.

**If your spa is installed in a 230VAC circuit:**  
**DANGER — RISK OF ELECTRICAL SHOCK**

Your spa must be equipped with a GFCI at the Main Electrical Panel. At initial startup and before each use thereafter with power ON, push the GFCI test button. The reset button should pop out. Push this button in to reset. If the interrupter fails to operate in this manner, there is a ground current flowing or a device malfunctioning, indicating the possibility of electrical shock. **Turn off power and do not use the spa until the source of the breakdown has been identified and corrected.**

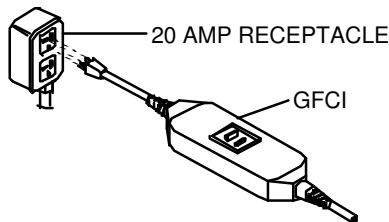

**If your spa is installed in a 115VAC, 20 AMP circuit:**

1. The spa is supplied with a 15 foot line cord which terminates with an integral GFCI plug. Locate the spa near enough to a weather protected outlet, but no closer than 10 feet. **DO NOT USE AN EXTENSION CORD!** Using an extension cord is hazardous and will decrease the amount of power to the unit, causing slow heating, poor whirlpool performance, or system malfunction.

2. Replace damaged line cord immediately. Do not bury line cord. Connect to a grounded, grounding type receptacle only.

3. Bring the line cord out from under the skirt. Remove skirt screws as required to gain access. Make sure the line cord does not lie across a walkway or in a heavily traveled area where it may be a safety hazard or become damaged.

4. At initial startup and before each use thereafter with power ON, push the GFCI test button. The reset button should pop out. Push this button in to reset. If the interrupter fails to operate in this manner, there is a ground current flowing or a device malfunctioning, indicating the possibility of electrical shock. **Turn off power and do not use the spa until the source of the breakdown has been identified and corrected.**

[www.clearcreekspas.com](http://www.clearcreekspas.com)

Read manufacturer's safety information provided with all optional equipment.

# Platinum Series Whirlpool Spa

## OWNER'S MANUAL

### Contents

<b>Installation</b> .....	<b>2</b>
Inspection and Shipping Claim.....	2
Positioning Your Spa .....	2
Electrical Requirements .....	2
Electrical Precautions .....	3
Outdoor Installation .....	3
Drainage.....	3
Indoor Installation.....	3
Equipment Set-Up.....	4
<b>Operation</b> .....	<b>5</b>
Operating Instructions .....	5
Control Panel .....	6
Control Panel Operation.....	7
Display Messages .....	8
Normal Operation/Whirlpool System.....	9
Air Blower.....	9
Water Rainbow®.....	9
Silent Air Induction .....	9
<b>Maintenance</b> .....	<b>10</b>
Water Quality and Water Chemistry.....	10
Filtration .....	10
Water Chemistry .....	10
Disinfecting.....	11
Balancing pH.....	11
Balancing Total Alkalinity .....	11
Water Quality Definitions.....	11
Water Level/Drain .....	12
Skimmer Basket Maintenance .....	12
Filter Maintenance.....	12
Automatic Filtration/Maintenance.....	13
Winterizing .....	13
Factory Installed Redwood Skirt .....	13
Spa Light .....	14
Cleaning Your Spa .....	14
Covering Your Spa.....	14
Repairs to the Acrylic .....	14
<b>Troubleshooting Guide</b> .....	<b>15</b>
<b>Alternate Use for Water Rainbow®</b> .....	<b>17</b>

---

#### Owner's Record

Date Purchased \_\_\_\_\_  
Purchased From \_\_\_\_\_  
Installed By \_\_\_\_\_  
Spa Serial Number \_\_\_\_\_ Model # \_\_\_\_\_

# INSTALLATION

## Inspection and Shipping Claim

Check for shipping damage upon receipt of the spa. Jacuzzi Whirlpool Bath is not responsible for damage to the spa sustained during shipment. If damage is evident before unpacking, refer to instructions regarding shipping claims on the outside of the carton and immediately file a claim with the carrier.

Once the spa has been removed from the carton and before it is permanently installed, check the spa completely for damage. Fill the shell with water and operate the system (refer to Operating Instructions) to check for leaks which may have resulted from improper shipping or handling. All Jacuzzi Whirlpool Bath spas are factory tested for proper operation and water tight connections prior to shipment. If leaks or other problems are detected, immediately notify your Jacuzzi Whirlpool Bath dealer, Authorized Service Agent, or call Jacuzzi Whirlpool Bath, (510) 938-7070, or (510) 938-7411 for Warranty Service.

**NOTE: Damage or defects which could have been discovered and repaired prior to installation and which are claimed after final installation of the spa, are excluded from our warranty.**

## Positioning Your Spa

Because your spa is portable, you can locate it just about anywhere you wish—on a deck, patio, or even indoors. Just be sure to position it above ground in an area with good drainage and on a level, continuous surface which can support the weight of the spa when filled with water and people. You must also provide access to the spa's equipment for service and general maintenance. See specifications sheet for minimum service access requirements.

## Electrical Requirements

Your spa requires a 230 VAC, 50 AMP, 4-wire, grounded type GFCI protected electrical service with copper conductors, and must be in a separate circuit having no other appliance connected in that circuit. If you do not have this kind of circuit, a qualified electrician should install the necessary wiring. Inadequately sized wiring may cause the unit to malfunction and bring about permanent damage to the spa's electrical system. The circuit must also have a ground wire in order to take advantage of the designed-in safety features of the spa. A bond wire must also be used. Bond according to procedure described on the next page.

**WARNING: Without proper grounding and bonding, a system malfunction may cause fatal shock.**

# INSTALLATION

## Electrical Precautions

CAUTION: Do NOT apply electrical power to the spa unless it is filled with water to the normal water level, which is approximately 7" below the spa rim (refer to location of water level indicator on face of skimmer). If the spa's motor/pumps are actuated when there is not sufficient water in the unit, the circulation pump could be irreparably damaged. Not heeding this caution will nullify the warranty. In addition to damaging the unit, operating the unit with insufficient water could cause a fire.

Do NOT locate lighting fixtures directly above the spa; lighting and electrical receptacles must be located at least 5 feet from the spa. Lighting located between 5 and 10 feet from the spa must be on a circuit protected by a GFCI. (Refer to National Electrical Code, 680-6.)

Do NOT use electrically connected devices, such as television, radio, telephones, stereo speakers, light or cooking devices within 5 feet of the spa when the spa is being used.

All fixed metal objects located within 5 feet of the spa, such as fence posts, railings, door frames, green-house structures, gutters, etc., must be attached to the bonding bar on the outside of the spa electrical cabinet using #8 solid copper wire. **With #8 solid copper wire, bond the spa to the house electrical panel or approved local bond.**

An approved ground may be an 8 foot long ground rod, a plate electrode, or a buried metal water pipe with at least 10 feet of buried pipe. Check your local building code for requirements. Bonding lugs are available at your local electrical supply store. (Bond bar location is shown below.)

## Outdoor Installation

If you install the spa outdoors, we recommend that you provide a concrete pad for it to rest on. To do this, construct forms for a 4" thick level pad. Install a #10 gauge wire mesh 6" x 6" steel reinforced grid. Attach a #8 solid copper wire to the grid with a ground clamp. This wire should be long enough to reach the bond bar on the spa electrical cabinet (minimum 36"), but should **NOT** be located under the base of the spa. Then pour the concrete pad.

## Drainage

Whether you install your spa indoors or outdoors, you can drain it completely by attaching a garden hose to the hose bibb (drain valve) located on the suction plumbing of the spa. Simply run the hose to the house sewer line or drain field and open the hose bibb.

Make sure the area surrounding the spa has good drainage to keep water from collecting at the base of the spa—especially near the equipment area. If drainage is poor, install a drain line and/or gravel drain field. (Refer to illustration below.)

## Indoor Installation

Water that splashes on the floor during spa use may cause a walking hazard and/or structural damage. Good drainage must be provided and proper waterproof building materials must be used in the area surrounding and beneath the spa. Take into consideration that high room humidity will exist due to high spa water temperatures. Providing natural or forced ventilation of the room will help maintain comfort and minimize moisture damage to the building. Jacuzzi Whirlpool Bath is not responsible for damages resulting from excess moisture or water spillage. Consult an architect or engineer for aid in designing your indoor installation.

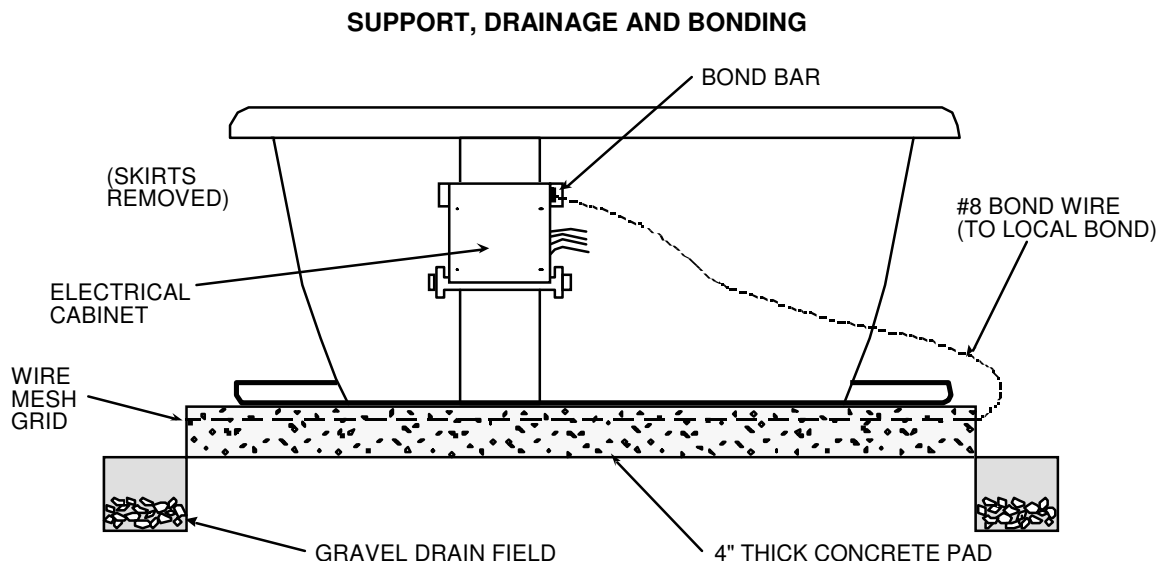



# INSTALLATION

## Equipment Set-Up

1. Remove the plastic sheet covering the spa.  
NOTE: Stepping into the spa with shoes will scratch the acrylic surface.
2. Remove any packing materials from the spa.
3. Remove the filter cartridge from its plastic bag.
4. Pull open the skimmer/filter door by the handle located in the middle of the door and remove the skimmer basket. Then insert the filter cartridge into the filter housing and reinsert the basket so that it fits in place over the filter cartridge and close the skimmer/filter door.
5. Clean the interior of the spa of any remaining construction debris. Remove stubborn stains, paint, or tar with turpentine, isopropyl alcohol or paint thinner. A mild liquid dishwashing detergent on a damp cloth is fine for cleaning off other dirt. Plaster can be removed by scraping with a soft plastic or wooden edge. Do not use a metal scraper, wire brush, or other metal tools, as they will damage the spa's surface.
6. Install the skirt panels which were not installed on the spa at the factory. Use the screws provided in your spa accessory package and follow instructions provided with the panels.
7. On initial start-up, it is necessary to purge and sanitize the system as stated below.
  - Remove the spa cover completely.
  - Close the drain valve on the suction plumbing.
  - Open the adjustable jets.
  - Fill the spa with water to its normal operating level, which is to the water level indicator mark on the skimmer/filter frame.

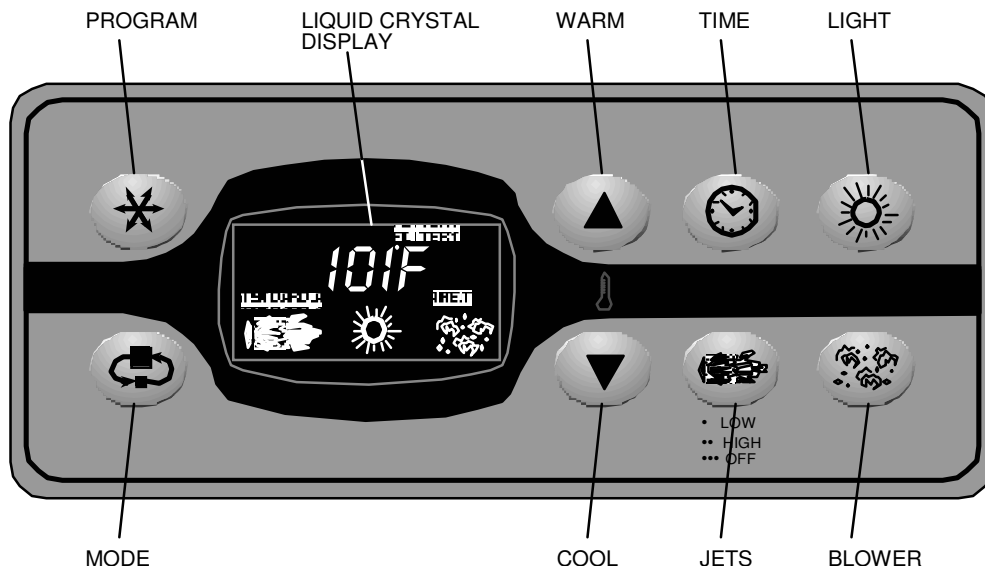





# OPERATION

## Operating Instructions

Now that the spa is in place, you are probably eager to take advantage of its unique designed-in features—especially the patented hydromassage performance. Besides being a beautiful addition to your indoor decor or outdoor landscaping, your Jacuzzi Whirlpool Bath spa will provide you with the ultimate in spa pleasure.

Familiarize yourself with the operation of the electronic control panel, as described on pages 7-9 of this manual. Access under the spa (behind the skirts) is required only to **drain** the water.

**WARNING: Do not turn ON power to the spa unless it is filled with water to the normal water level. Refer to water line indicator mark on skimmer frame. Whenever the power is ON, the system may activate even though no controls are operated. If the spa's motor/pump is actuated when there is not sufficient water in the unit, the circulation pump and heater could be irreparably damaged. Not heeding this caution will nullify the warranty. In addition to damaging the unit, operating the spa with insufficient water could cause a fire.**

### Initial Instructions

- Using a garden hose, fill the spa with water to the water line indicator mark on the skimmer frame. (Refer to information on using the Water Rainbow as a fill spout if desired.)
- At the house service panel, turn ON the circuit breaker or switch that controls the electrical service to your spa. Make sure there is no other appliance on that circuit.
- Your spa must be installed in an electrical circuit protected with a ground fault circuit interrupter (GFCI) (refer to Electrical Requirements). At initial start-up and before each use thereafter, with power ON, push the GFCI test button. The reset button should pop out. Push this button in to reset. If the interrupter fails to operate in this manner, there is a ground current flowing or a device malfunctioning, indicating the possibility of electric shock.  
**DANGER: Turn OFF power and do not use the spa until the source of the problem has been identified and corrected.**



# OPERATION

## Control Panel

The control panel is easy to use with fingertip control of all the spa's functions. Control of temperature, jets, blower, filtration and spa light is readily accessible at your fingertips.

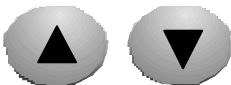
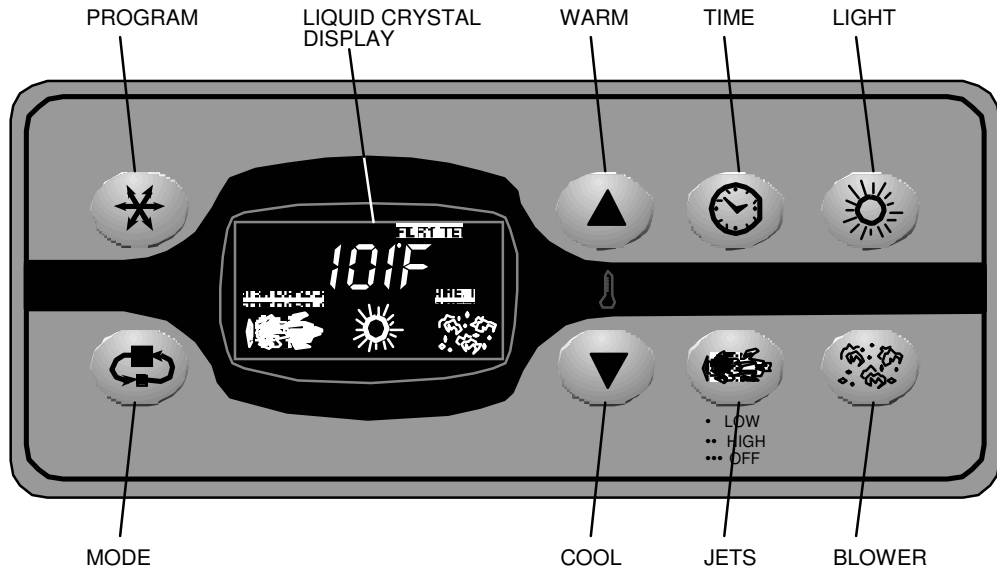

**Temperature Controls:** When either of these buttons is pressed once, the display will show the temperature that has been set, in

addition to the words SET HEAT. Each time either of these buttons is pressed again, the set temperature will increase or decrease in increments of 1 °F depending on which button is pressed. After 3 seconds, the display will automatically show the current spa water temperature.

**Jets Control:** Press this button once to activate the low-speed jet operation. Press again to start the high-speed jet operation, and again to turn OFF the jets. The low-speed will start automatically when the heater is turned ON or when a filter cycle is activated. If automatic activation occurs, the low-speed cannot be turned OFF with the jets button; however, the high-speed may be started. When a freezing condition is detected, high speed jets are automatically activated.

Whenever the low-speed is started with this button, it will automatically stop after 4 hours of operation. The high-speed automatically turns off after 30 minutes.



**Blower:** Starts or stops the blower for aeration in the spa.

The blower will also automatically stop after 30 minutes of operation.



**Light:** Press the button once to activate the highest setting, again for the medium setting and again for the lowest setting. A fourth press of the button will turn the light OFF.

The light automatically turns OFF after 4 hours of operation.



**Time:** Press to display time of day, press again to display temperature. Current spa temperature display will automatically resume after five seconds.



**Program Function:** Initiates time setting, filter programming, and panel lock routines.



**Mode Function:** Switches spa operation to either the economy or standard mode. In the economy mode, the spa will heat only during the filter cycles and only when the water temperature is 20 °F below the setpoint. In the standard mode, the spa will continuously heat to the set temperature.

## Liquid Crystal Display



Continually shows operating status of the spa, as well as the various monitoring functions and programming information.



# OPERATION

## Control Panel Operation

### Initial Start-Up

The spa will automatically begin to operate when electrical power is applied. There is no ON/OFF switch for the spa system.



The control system is designed so that by simply connecting the spa to its properly grounded power source and pressing the mode button, the spa will function properly and safely at 100°F. In this mode, all control panel buttons are completely functional. To use the full capabilities, it is important to set the time of day.

#### Setting the Time of Day:

Press  then .

then  or .

After either button is pressed once, hours will advance or decrease automatically in one-minute increments.

Press either  or  again to stop the display's time-setting cycle.

### Filter Cycles

The spa is filtered for 2 hours, twice a day. The display will show FILTER during filtration. The blower will activate for 30 seconds at the start of each filter cycle to clean out the air channel. The ozone generator also operates during the filter cycles.

**Note: The ozone generator will be disabled for 1 hour whenever the pump, blower, or light button is pressed.**

#### Changing Filter Cycles

If the preset times are inconvenient, if a different duration is preferred, or if you wish to leave the heater OFF during filtering, the following procedure can be used to change the automatic filter cycle settings.



Press . Time of day will be shown. Then press

. SET TIME message will be shown. Then

press . SET START FILTER 1 message will be shown. At this point, each time the program button is pressed, the filter start time, the heater enable status, and the filter stop time will be indicated on the display. When the filter start or filter stop times are displayed,

press  or  to reset the times.

When the SET HEAT message is displayed, press

 or  to set the center display to ON or OFF. In the ON position, the spa will warm to the set temperature during the filter cycles. In the OFF position, the heater, in the economy mode, will not be activated during the filter cycles.

After the filter set routine, press  to proceed through all the start and stop times for both filter cycles. Follow the same procedure to adjust the FILTER 2

settings. To exit the filter set routine press

and the display will show the current water temperature.

**Note: To properly clean and maintain your spa, filtering time of at least two hours per day (total of both cycles) is recommended.**

### Panel Lock



The panel lock is provided to prevent tampering with the control panel. When the panel lock is engaged, all the automatic spa functions will operate normally.

Press these buttons within 3 seconds to activate the lock. When locked, the display will show the spa temperature along with the lock symbol. All the panel buttons are now deactivated except the program button, which is used to initiate the unlock sequence.

Press . The center display will read `LOC`.



Then . The center display will read `0`.

# OPERATION

Then . The center display will read .

## Temperature Lock



The temperature lock is provided to prevent unauthorized temperature adjustment of your spa. While setting your spa water temperature, and after you have pressed

 or , follow the instructions below to lock the set temperature. When the temperature lock is engaged, all automatic spa functions will operate normally.

These buttons must be pressed within 3 seconds to activate the lock. When locked, the display will show the spa temperature, the lock symbol, and the words SET HEAT. When the spa is in the temperature locked mode, the temperature buttons are deactivated. When pressed, the set temperature will appear with a double arrow next to it.

Press . The display will read *LOC F*.

Then . The display will read *0*.

Then . The display will read  *SET HEAT*.

## Unlocking the Panel

To unlock the panel, these buttons must be pressed in the correct sequence and within 2 seconds. When the last button is touched, the lock symbol will disappear. All buttons are now active.

Press  then  then .

## Display Messages

These are some of the messages you will see on the center display.

Message    Meaning

*Pd*        Battery Backup: Power has been cut OFF to the spa. It is using its 15-minute rechargeable battery backup to preserve its settings. The control panel will be disabled until power returns to the unit.

*OH*        Overheat Protection: Spa is deactivated. If a malfunction occurs and the spa water reaches 112°F, the system will completely shut down.

**DANGER: DO NOT ENTER THE WATER. Turn off all power to the spa and contact your dealer or service organization. Press any panel button to reset.**

*FL0*        Flow Switch (Constantly displayed): A pressure switch has malfunctioned. Contact your dealer or service organization.

*FL0*        Flow Switch (Flashing): 1) The filter may be plugged. Remove the filter and clean. 2) The amount of water may be inadequate. Be sure the spa is properly filled. 3) A pressure switch has malfunctioned. The spa will operate, but the heater will not activate. Contact your dealer or service organization.

Message    Meaning

*COOL*      Temperature Set Back: If the spa water is more than 20°F cooler than the temperature set point, the filter pump and heater will automatically activate. This is a normal spa function; no corrective action is necessary.

*ICE*        Freeze Protection: If a freeze condition is detected, the pump is automatically activated. This is also a normal spa function; no corrective action is necessary.

*Sn1*        Open Sensor: Spa is deactivated. The high limit temperature sensor is nonfunctional. This must be repaired by a dealer or service organization.

*Sn3*        Open Sensor: Spa is deactivated. The water sensor is nonfunctional. This also must be repaired by a dealer or service organization.





# OPERATION

## Normal Operation/Whirlpool System

You can enjoy the spa with or without activating the whirlpool. Either way, bathing in your spa can be pleasurable, as well as therapeutic. After a busy, stressful day, you can look forward to soaking in your spa in still water with no turbulence—only the gentle warmth of the soothing and relaxing water.

For a more invigorating spa experience, you can take advantage of the built-in whirlpool system. To do this, press the JETS button for low or high speed JETS. Sit or recline in the spa so you are comfortable. Since all the jets are directionally adjustable, you can direct a jet toward an area where muscles feel tense or stiff. The warmth of the water and the stimulating water flow from the jets will pleasantly increase circulation.

For the total whirlpool effect and all over feeling of well being, you can adjust all jets so they point in a clockwise or counterclockwise direction to circulate the air and water mixture in a circular motion all about the spa.

## Air Blower

The spa features a built-in air blower and factory drilled air holes in the seats of the spa to add to your enjoyment.

The blower sends air to a channel located under the spa's seats; this air is distributed through the air holes, and as the pressurized air is released from the holes, tiny bubbles are formed. These bubbles travel upward through the water and expand until they reach the surface and burst. The exciting visual effect of the bursting bubbles contributes to the overall hydromassage experience.

### DIRECTIONALLY ADJUSTABLE WHIRLPOOL JETS

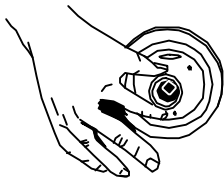

FULLY ADJUSTABLE WHIRLPOOL JETS

## Water Rainbow™

Activate the waterfall feature by rotating downward the flow control lever located on the left side of the spout. Use this lever to adjust the amount of water flowing through the Water Rainbow spout. The waterfall effect will be greatest in the high-speed JETS mode. Turning OFF the flow at the fully adjustable jets will dramatically increase flow through the Water Rainbow.

**CAUTION: The water circulating through the Water Rainbow spout is not fresh water and therefore is NOT suitable for drinking.**

## WATER RAINBOW

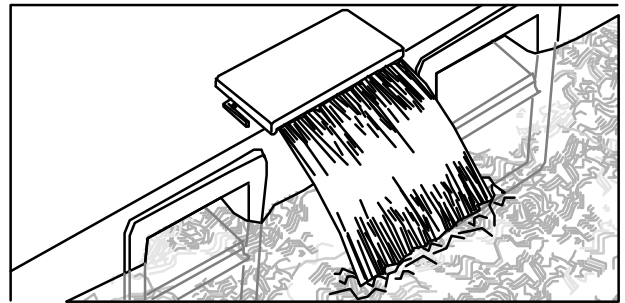

## Silent Air Induction

The intensity of the whirlpool action is determined by how much air is induced into the water. You control this by adjusting the air induction control knobs located on spa rim. For maximum air induction, rotate each control knob fully counter clockwise to the largest circle. For fewer air bubbles, decrease the amount of air induction by rotating the control knobs clockwise. When the knobs are turned to the smallest circles, only water is being circulated. (Refer to illustration below.)

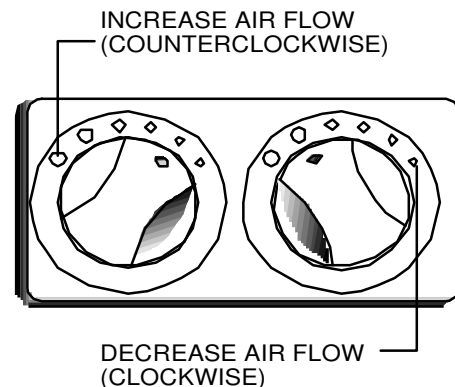

AIR INDUCTION CONTROLS



# MAINTENANCE

## Water Quality and Water Chemistry

Maintaining water quality and water chemistry in your spa is extremely important and should be a regular part of your spa maintenance program, as a neglected spa can be a breeding place for dangerous bacteria.

The water quality of your spa is maintained by a combination of filtration and chemistry. The spa's integral filter system helps maintain the water cleanliness and clarity by trapping most solid materials such as hair, and other debris resulting from normal use. However, the most important part of maintaining water chemistry is keeping the proper level of disinfectant in the water at all times. This is accomplished by adding chlorine or bromine to the water, which will control particles too small to be trapped by the filter, such as bacteria and algae, and will oxidize any organic materials. Follow instructions provided here and with water quality products for the health and safety of spa users, as well as to make your spa bathing as enjoyable as possible.

Your Platinum Series spa is factory equipped with an ozone generator which operates automatically during the system filter cycles. Ozone is fed into the spa through a fitting in the footwell where it dissolves in the water. Ozone is used in conjunction with chlorine or bromine to assist in disinfecting and clarifying the water. Use of the ozone generator will generally reduce the requirement for, and the cost of water quality maintenance chemicals.

## Filtration

The filtration system of your spa will keep your water clear and clean if used properly. The filter cartridge elements will trap most solid materials and debris in the water. However, the presence of materials such as body oils or other particles which are too small to be captured in the filters may bring about various undesirable water quality conditions. These conditions can be corrected with the use of spa treatment chemicals which are available from your Jacuzzi Whirlpool Bath dealer. Such conditions include the following:

**Foaming:** A defoamer is available to minimize foaming of the water. This condition is usually caused by the addition of soaps or oils, or other fatty substances to the spa water. The interaction of these with hot water, especially at high pH (more alkaline), will cause the water to foam. (Refer to Water Quality Definitions.)

**Oil Film or Cloudy Water:** Add clarifier to congeal oil film on the water surface into globules sufficiently large to be trapped by the system's filter. Cloudiness is caused by particles that are too small to be trapped in the filter, and is also due to the presence of human body oils, lotions, and cosmetics. During normal use, these materials can accumulate on the filter element and clog its pores. The addition of clarifier will make the water clearer, but clogged filters must be cleaned as prescribed under the section entitled Filter Maintenance in this manual.

**Hard Water:** Add a demineralizer to break down or deionize mineral particles present in the spa water.

Follow the Filter Maintenance procedure described in this manual to ensure optimum performance of your spa's filtration system.

## Water Chemistry

You can ensure better water chemistry by testing your spa water every day and adjusting the chemical balance frequently. Obtain a water quality test kit, designed especially for spas, from your Jacuzzi Whirlpool Bath dealer. The test kit must be of the type which allows you to test for the disinfectant (chlorine) level, pH, and total alkalinity. Ensure that the chemicals used in your spa are especially for spa use, and not for swimming pools, as water quality maintenance of spas and of swimming pools is very different.

Set up a daily program at first to check the disinfectant level, pH, and total alkalinity of the water. Familiarize yourself with the amount of chemicals to add and to determine how often to make chemical adjustments during normal use. Remember that the more heavily the spa is used, the more often you should check the water chemistry.

When adding any chemicals, always run the filter system to ensure complete dilution with the water.

**Do not add chemicals directly into the skimmer.**

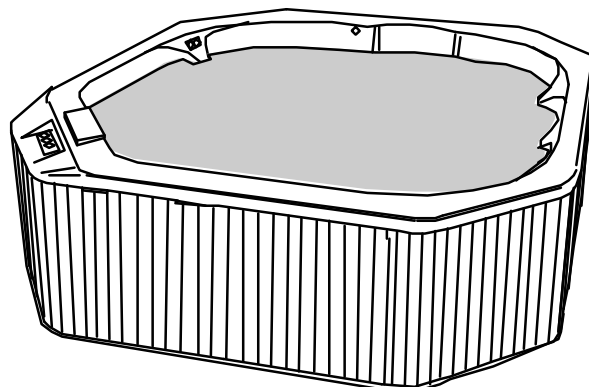



# MAINTENANCE

## Water Chemistry (Continued)

### Disinfecting

When filling the spa for the first time, follow the purge/sanitizing instructions in the Equipment Set-Up procedure of the Installation Instructions.

Add a disinfectant to the water on a regular basis to help control the amount of bacteria, algae and organic materials. Such bacterial contaminants, if not controlled, could cause skin rashes or other physical problems. To disinfect the spa for normal use, first establish the amount of chlorine or bromine to add and determine how often you need to add it.

We recommend that you maintain a free chlorine level of 2.0-5.0 ppm at all times except when you must exceed that during the initial purge/sanitizing procedure or during superchlorination (refer to Water Quality Definitions below). Superchlorinate your spa every two weeks with heavy use. If using sodium dichlor, add one heaping tablespoon for each 150 gallons of spa water. Scrub the spa surfaces with this solution to remove any oily deposits. This will ensure that any bacteria or algae which are resistant to the normal disinfectant level are killed. After adding the disinfectant, run the filter system and allow the free chlorine level to return to the 2.0 to 5.0 ppm range before using the spa again.

**Do not install a cover until the disinfectant level is back to normal. High concentrations of chlorine or bromine will damage metallic plated finishes if the cover is in place.**

### Balancing pH

For good hygiene and equipment longevity, maintain the pH of your spa water according to the instructions provided. pH is the measure to determine if the spa water is too acid (low pH, or too alkaline, or basic high pH). The ideal range for spa water is 7.2 to 7.6 pH. For excessive acidity (below 7.2 pH) add soda ash or sodium bicarbonate to the spa water. For excessive alkalinity (above 7.6 pH) add dry acid to the spa water.

**CAUTION: Refer to the spa chemical manufacturer's instructions for the initial amount of chemicals to add for the gallonage of your spa. Low pH can cause equipment damage, as acid water will dissolve metals, while high pH can cause scale or calcium deposits to build up in the system or on the shell. After adding chemicals, run the filter system for at least 30 minutes before testing water quality again for accurate readings.**

### Balancing Total Alkalinity

Total alkalinity is the measure of base materials in the water. The recommended range for total alkalinity is between 80 ppm and 150 ppm. If the chemistry of the water is not within this range, you will have difficulty adjusting your pH level, which will affect your adjustments for the proper amount of free available chlorine. If the alkalinity of your spa water is high, it is advisable to drain the water from the spa and begin the balancing process over again. Purge and sanitize your spa (according to instructions in Equipment Set-Up section of the Installation Instructions) and clean the spa surfaces thoroughly before refilling with fresh water. Then reestablish water chemistry. If the spa is used heavily, change the water at least every month.

## WATER QUALITY DEFINITIONS

**pH:** A chemical term used in expressing relative acidity or alkalinity in numeric values with 7.0 usually regarded as neutral, and for purposes of this manual, indicating pure water. From 7 to 0 indicates increasing acidity, and 7 to 14 indicates alkalinity.

**PPM:** Parts per million.

**Ozone:** triatomic oxygen (O<sub>3</sub>), a gas found commonly in nature, which, when dissolved in spa water helps to destroy impurities and contaminants.

**Free Chlorine:** Chlorine that has not combined with other chemicals and that is available to destroy bacteria in the spa water.

**Trichlor:** A form of chlorine used in pool or spa water treatment; usually supplied in tablet form. Not recommended because of its higher acidic nature and slow dissolving action. Prolonged contact with the spa shell may bleach or permanently mark the shell.

**Sodium dichlor:** The type of chlorine that is recommended for spa use, as it is available in fast dissolving granular form. It is neither excessively acid nor alkaline in character and does not readily dissipate in higher water temperatures.

**Calcium Hypochlorite:** A granular chlorine product that is inexpensive and effective but not recommended because it often tends to form calcium deposits on heater parts and plumbing fittings and leaves an unattractive film on the spa at the water line.

**Sodium Hypochlorite:** A liquid chlorine product that is inexpensive and effective but not recommended because the liquid is readily spilled onto the spa or a surrounding area, causing permanent damage.

**Total Alkalinity:** The measure of the amount of alkaline materials (such as carbonates, bicarbonates and hydroxides) in the water. High alkalinity inhibits the effectiveness of chemicals to change the pH. If the alkalinity of your spa water is high (above 150 ppm), it is advisable to drain the water from the spa and begin the balancing process over again. Low total alkalinity (below 60 ppm) could be corrosive and damage your spa system.

**Superchlorination:** (Also referred to as shock treatment.) The addition of an above-normal level of disinfectant to kill any bacteria or algae that might have become resistant to normal levels of disinfectant.



# MAINTENANCE

## Water Level/Drain

The water level in the spa must be maintained at its normal level. Evaporation and splashing will cause the water level to drop.

When concentrations of impurities from evaporation, water quality chemicals, body oils, perfumes, dirty feet, and winds, etc., accumulate in the spa and cannot be filtered out, it is necessary to drain your spa and refill it with fresh water. This should be done every 2 months or more often depending on the amount of use.

To drain the spa, turn OFF circuit breakers at the main electrical panel. Connect a garden hose to the drain valve in the suction plumbing, via access hole in the pan. Turn the handle and drain the spa.

After draining the spa, clean the spa shell, suction cover, skimmer, and filter, then close the drain valve and refill the spa with fresh water. Check the pH level and maintain water quality.

## NORMAL WATER LEVEL

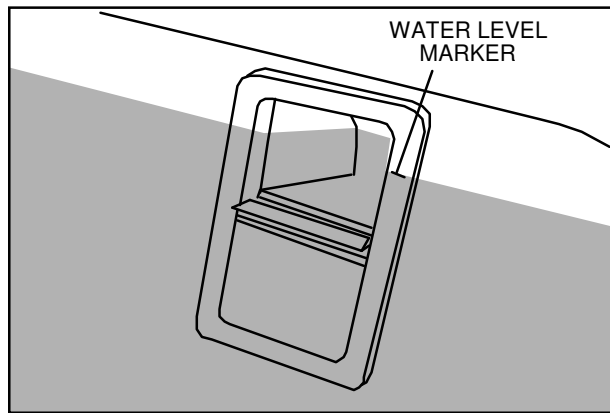

The suction cover located in the foot well area should be checked at least once a week for collected debris, such as leaves, hair, etc., and cleaned as necessary. It may not be necessary to remove the suction cover to clean it, but if you need to, remove the center screw with a Phillips screwdriver and clean the cover by flushing with water from a hose.

**CAUTION: Ensure replacement of the suction cover immediately after cleaning. It is a safety device and must be in place over the suction fitting to minimize potential hazard of hair and body entrapment.**

If heavy rains raise the spa water level, drain the spa to its normal level.

A spa cover (available as an option), when in place over the spa, will help reduce evaporation and control the amount of debris entering the spa when the spa is not occupied. In addition, its use will reduce energy consumption.

## Skimmer Basket Maintenance

The basket located in the skimmer of the spa should be checked at least once a week for collection of debris, such as leaves, hair, etc., and cleaned as necessary. To clean the basket, remove it from the skimmer by pulling it out, then backflush it with a garden hose and reinstall.

## FRONT ACCESS SKIMMER/FILTER

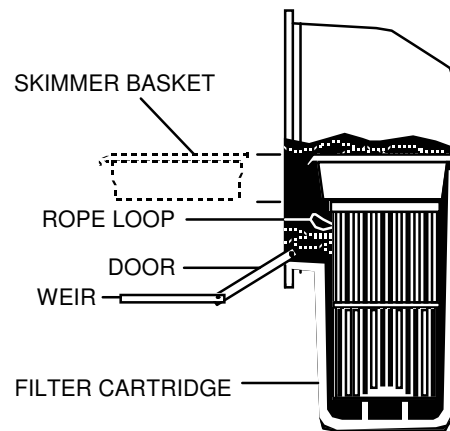

## Filter Maintenance

The filter should be checked periodically. In normal use, check the filter at least once a month. Keep the filter clean. An obstructed filter reduces water quality and inhibits proper system performance.

A removable filter cartridge is located inside the skimmer. To remove it, pull open the skimmer door by the handle located in the middle of the door. Slide the basket out, then pull the filter cartridge upward and out of the housing by the loop at the top of the filter. Clean the filter by separating the folds of the filter and spraying with fresh water from a garden hose. Then reinstall the cartridge in the housing and replace the basket, reversing the above procedure.

Oils will coat the filter, resulting in a reduced flow. To remove such materials, soak the cartridge in a plastic pail containing a commercial filter cleaning solution (available from your Jacuzzi Whirlpool Bath dealer or most pool supply stores). Follow the manufacturer's instructions for use. Another method is to soak the filter cartridge in a plastic pail containing a mild solution of trisodium phosphate (TSP) and water. An hour of soaking time is usually required to break down oil coatings from the cartridge. Use a stronger solution of TSP and water to remove algae. Most hardware or paint stores stock TSP. Use the same method of cleaning when the cartridge becomes plugged with clay or vegetation. Replacement cartridges are available through your Jacuzzi Whirlpool Bath dealer.





# MAINTENANCE

## Automatic Filtration/Maintenance

If you plan to be away, minimum water quality will be maintained by running the filter system.

If you will be away for an extended period, however, we recommend that you drain the spa (following the procedure described under Winterizing on this page), as long periods without maintenance of water quality could be detrimental to the spa.

Another means of maintaining minimum water quality while away for less than two weeks is to follow the procedure outlined for winterizing your spa in a warm climate. (Refer to Winterizing.)

**NOTE: We do not recommend using this procedure if you are absent during the summer, when algae buildup is most likely.**

Always keep your spa covered when not in use to reduce heat loss and evaporation and to prevent debris from falling in.

## Winterizing

**In a climate where winter temperatures are below freezing, follow this procedure when the spa will NOT be used:**

1. Turn OFF power to the unit at the main electric panel.
2. Drain the spa completely by attaching a garden hose to the drain valve on the suction plumbing. Then remove the hose and leave the drain valve open to completely drain the spa.
3. Remove, clean and store the filter cartridges, in a dry location.
4. Keep water and debris out by covering with a spa cover.

Before using the spa again, review the Operating Instructions.

**NOTE: In a warm climate where there are occasional freezing temperatures, your spa is automatically protected against freezing. Whenever water temperature falls below 40°F, the pump will activate to circulate water until the temperature reaches 45°F.**

To maintain water quality adjust temperature setpoint to the minimum setting (80°F), and select ECONOMY mode.

## Factory Installed Redwood Skirt

Your spa is supplied with a factory-installed redwood skirt which completely surrounds the spa. The door can be opened for maintenance.

The skirt is made of kiln-dried redwood and can be left natural to weather, or you may choose to apply a stain or clear finish. Consult your local paint dealer for the appropriate product.

**NOTE: We recommend a water based material. Oil or solvent based finishing materials will degrade the skirt backing material.**

If it becomes necessary to remove one or more of the skirt panels for major service access, simply remove the screws with which the section is secured.

To detach any of the panels, first remove all screws from the panel being detached.

The panels can be reattached to the spa by reversing the above procedure.

**NOTE: When you remove the skirt, you will notice the plastic covered foam insulated batts. These batts are designed to be removed when service is required and reinstalled when service has been completed.**

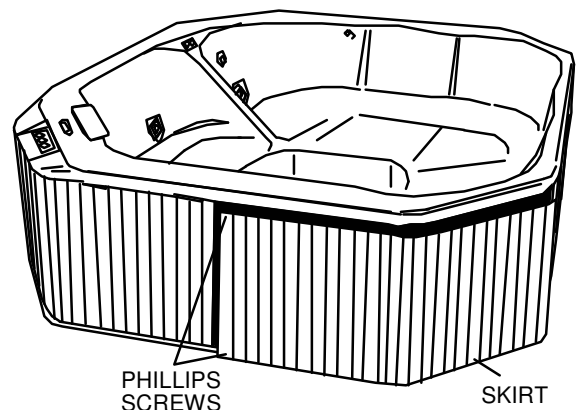



# MAINTENANCE

## Spa Light

Two filters, one blue and one red, are provided with your spa. To change the filter, simply snap the colored filters in place on top of the normal lens. Two replacement bulbs (GE#912, 12W, 12V) are also included. Put them in a safe place for future use. When a bulb burns out, replace it from the **back** of the light fitting on the outside of the shell by pulling out the bulb receptacle.

### LIGHT BULB REPLACEMENT

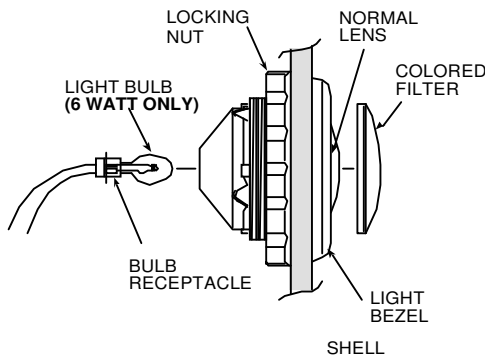

## Cleaning Your Spa

Your spa shell consists of two layers of plastic materials. Its smooth top surface of acrylic is tough and durable and contains concentrated color. This is supported by a substantial thickness of fiberglass-reinforced polyester resin. A catalyst causes a chemical reaction during manufacture that bonds these layers permanently into a hard, strong material. With a minimum amount of care and cleaning, your whirlpool spa will look new for years.

To clean your spa, simply use a mild, nonabrasive liquid detergent, isopropyl alcohol, or commercially prepared spa cleaner. **Do not use abrasive cleaners.** You can protect and restore the gloss to a dulled surface by applying Meguiar's #10 Mirror Glaze, which is a product specifically designed for use on acrylic finishes. If Meguiar's is not available, an acrylic polish of equal quality or automotive paste wax will do.

Use a spa cleaner for residue buildup at the water level of the spa surface. This may be applied to the acrylic surface with a soft cloth and wiped clean. Use sparingly in small amounts to avoid contaminating the spa water. If the water line is heavily soiled, it may be advisable to lower the water level 2-3 inches before cleaning; then refill to normal level.

## Covering Your Spa

An optional spa cover for your spa is available from your Jacuzzi Whirlpool Bath dealer. Use of this cover will help to reduce energy costs by minimizing heat loss and evaporation. In addition, the attractive cover is an effective means of preventing debris such as leaves and dirt from entering your spa when not in use. Follow the instructions for use and care provided with the spa cover.

**CAUTION: The spa cover is not designed to support any weight. Therefore, as a safety precaution and to preserve the life of your cover, you must not sit, stand, or lie on it; nor should you place objects of any kind on top of it.**

**NOTE: Jacuzzi Whirlpool Bath does not guarantee or warrant this cover. Refer to spa cover manufacturer's information provided with the cover.**

### SPA SHOWN WITH INSULATING COVER

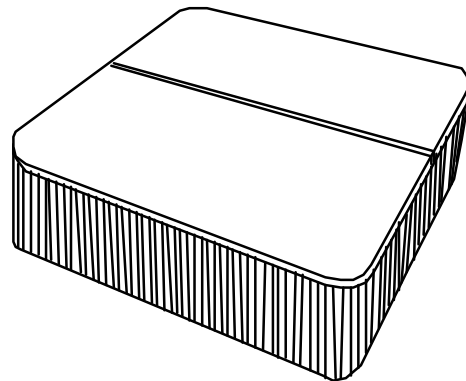

## Repairs to the Acrylic

Minor scratches which do not penetrate the color finish (acrylic) can be removed with 600-grit wet/dry sandpaper. Restore the glossy finish with Meguiar's #10 Mirror Glaze or comparable automotive paste wax.

Major scratches or gouges which penetrate the acrylic surface will require refinishing. Ask your Jacuzzi Whirlpool Bath dealer for special instructions.

## Headrest Pillows

Clean the urethane pillows regularly with soap and water and a clean cloth. Use ARMORALL® or similar protective cleaning agent once a month to maintain the water resistance and lustrous finish. Position the headrest pillow at least 3" above the spa water level. Remove the pillow from the spa if chlorine shock treatment is used.



# TROUBLESHOOTING GUIDE

**\*NOTE:** See also DISPLAY MESSAGES on page 9.

PROBLEM	PROBABLE CAUSE	REMEDY
<b>1. Water not clean.</b>	<ul style="list-style-type: none"> <li>A. Clogged or blocked suction strainer or skimmer basket.</li> <li>B. Filter clogged (dirty).</li> <li>C. Poor water chemistry.</li> <li>D. Insufficient filtering.</li> <li>E. Improper maintenance.</li> <li>F. High content of solids in water.</li> <li>G. Filter motor plug not connected to the electrical cabinet.</li> </ul>	<ul style="list-style-type: none"> <li>A. Clean strainer/skimmer.</li> <li>B. Clean or replace filter.</li> <li>C. See Chemistry section.</li> <li>D. Increase daily filtering time.</li> <li>E. See Maintenance section.</li> <li>F. Use clarifier or drain and refill spa.</li> <li>G. Check filter motor connection on the electrical cabinet.</li> </ul>
<b>2. Abnormal water usage.</b>	<ul style="list-style-type: none"> <li>A. Leak in suction line, discharge line, or connections.</li> <li>B. Excessive evaporation and/or splashing.</li> </ul>	<ul style="list-style-type: none"> <li>A. Repair leak.</li> <li>B. Use rigid spa cover; lower thermostat setting.</li> </ul>
<b>3. Low water flow from jets.</b>	<ul style="list-style-type: none"> <li>A. Normal operation in low speed jets, filter mode.</li> <li>B. Low water level.</li> <li>C. Clogged or blocked suction strainer or skimmer basket.</li> <li>D. Dirty filter.</li> <li>E. Adjustable jet partially closed.</li> <li>F. Suction or discharge line partially plugged.</li> <li>G. Pump running at subnormal speed.</li> <li>H. Worn or damaged pump seal.</li> <li>I. Subnormal voltage.</li> </ul>	<ul style="list-style-type: none"> <li>A. Select high speed jets mode for maximum flow.</li> <li>B. Fill to water level indicator mark on skimmer/filter frame.</li> <li>C. Clean strainers or skimmer baskets.</li> <li>D. Clean or replace filter.</li> <li>E. Open jet.</li> <li>F. *</li> <li>G. *</li> <li>H. *</li> <li>I. Call an electrician or your power company.</li> </ul>
<b>4. No water flow from jets.</b>	<ul style="list-style-type: none"> <li>A. Power turned OFF.</li> <li>B. Pump OFF.</li> <li>C. Motor(s) not connected.</li> <li>D. House circuit breaker tripped; no power to system.</li> <li>E. GFCI tripped.</li> <li>F. Faulty pump or motor.</li> </ul>	<ul style="list-style-type: none"> <li>A. Turn ON power at service panel.</li> <li>B. Press jets button.</li> <li>C. Check motor plug connections on electrical cabinet.</li> <li>D. Reset circuit breaker.</li> <li>E. Reset GFCI.</li> <li>F. *</li> </ul>

**\*NOTE:** The skills and tools necessary for the safe repair of this spa require the services of qualified service personnel. **Contact** your Jacuzzi Whirlpool Bath dealer.



# TROUBLESHOOTING GUIDE

PROBLEM	PROBABLE CAUSE	REMEDY
<b>5. Noisy pump and motor.</b>	<ul style="list-style-type: none"> <li>A. Clogged strainer(s).</li> <li>B. Leakage of air into suction line.</li> <li>C. Vibrating parts attached to motor or support brackets.</li> <li>D. Low water level.</li> <li>E. Damaged or worn motor bearings.</li> <li>F. Impeller rubbing inside case.</li> <li>G. Debris inside pump.</li> </ul>	<ul style="list-style-type: none"> <li>A. Clean strainers</li> <li>B. Locate and repair leaks.</li> <li>C. Tighten fasteners.</li> <li>D. Add water to normal level.</li> <li>E. *</li> <li>F. *</li> <li>G. *</li> </ul>
<b>6. Water leakage at pump shaft (rotating connection between pump and motor).</b>	<ul style="list-style-type: none"> <li>A. Worn or damaged pump seal.</li> </ul>	<ul style="list-style-type: none"> <li>A. *</li> </ul>
<b>7. Motor will not start.</b>	<ul style="list-style-type: none"> <li>A. Power OFF.</li> <li>B. House circuit breaker tripped or in OFF position.</li> <li>C. GFCI tripped.</li> <li>D. Subnormal voltage.</li> <li>E. Improper or defective wiring.</li> <li>F. Locked shaft or impeller.</li> <li>G. Motor windings burned out.</li> <li>H. Defective starting switch inside motor.</li> </ul>	<ul style="list-style-type: none"> <li>A. Turn ON power at service panel.</li> <li>B. Reset circuit breaker.</li> <li>C. Reset GFCI.</li> <li>D. Call an electrician or your power company.</li> <li>E. *</li> <li>F. *</li> <li>G. *</li> <li>H. *</li> </ul>
<b>8. Motor stops.</b>	<ul style="list-style-type: none"> <li>A. Motor overload condition.</li> <li>B. Inadequate supply wiring.</li> </ul>	<ul style="list-style-type: none"> <li>A. Let cool for one hour. Motor overload will reset; if problem persists, see *Note.</li> <li>B. Consult electrician to correct wiring to unit.</li> </ul>
<b>9. Air blower does not operate.</b>	<ul style="list-style-type: none"> <li>A. Power OFF.</li> <li>B. Switch is OFF.</li> <li>C. House circuit breaker tripped, no power to system.</li> <li>D. GFCI tripped.</li> <li>E. Faulty motor.</li> </ul>	<ul style="list-style-type: none"> <li>A. Turn power ON at service panel.</li> <li>B. Press blower button.</li> <li>C. Reset circuit breaker.</li> <li>D. Reset GFCI.</li> <li>E. *</li> </ul>

**\*NOTE:** The skills and tools necessary for the safe repair of this spa require the services of qualified service personnel. **Contact** your Jacuzzi Whirlpool Bath dealer.





## Alternate Use of Water Rainbow® as Fill Spout

You can use your Water Rainbow as a fill spout by permanently plumbing it to a fresh water supply if local codes permit. Local plumbing codes may require the use of an anti-siphon valve for such a connection. **Do not interconnect water supply with recirculating system of the spa.**

To make the connections necessary to use the Water Rainbow as a fill spout, follow this procedure:

- Make sure spa is unplugged and completely drained.
- Unscrew the spout from the 3/4" pipe.
- Cut the 3/4" piping as shown in the illustration below.
- Cap the piping by cementing a 3/4" PVC cap where cut has been made.
- Connect permanent plumbing line to the spout.

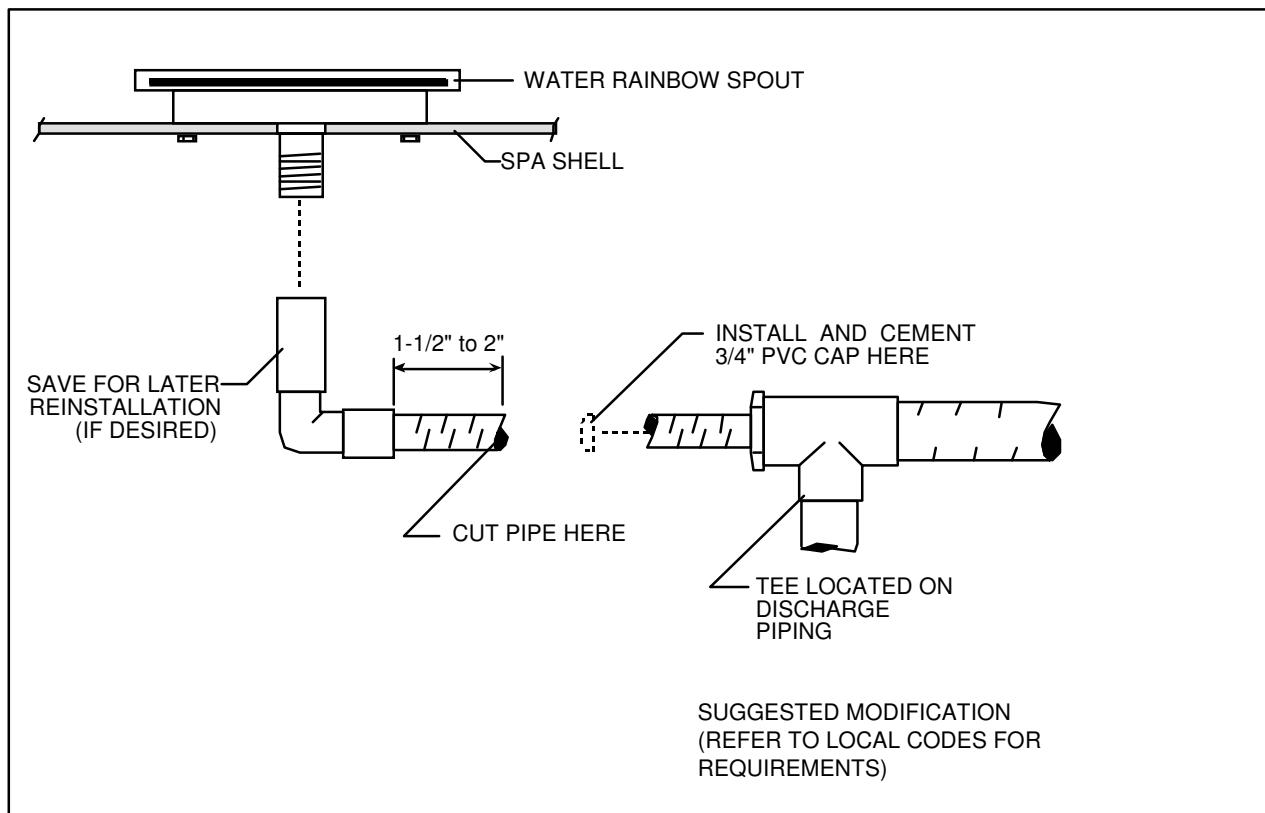



**PRODUCT SPECIFICATIONS ARE SUBJECT TO CHANGE WITHOUT NOTICE.  
USE INSTALLATION INSTRUCTIONS SUPPLIED WITH PRODUCT.**

Jacuzzi Whirlpool Bath has obtained applicable code (standards) listings generally available on a national basis for products of this type. It is the responsibility of the installer/owner to determine specific local code compliance prior to installation of this product. Jacuzzi Whirlpool Bath makes no representation or warranty regarding, and will not be responsible for any code compliance.

---

**JACUZZI WHIRLPOOL BATH**

**Jacuzzi Whirlpool Bath National Headquarters**

P.O. Drawer J, Walnut Creek, CA 94596 (510) 938-7070

Service Support: Call (800) 288-4002

